

Service Manual



Lenco

Stereo Amplifier A 50

Correct Ordering of Spare Parts

When ordering spare parts please specify the complete name, part number, and the relevant page number of the service manual for each required part.

By this method you will be sure to obtain the required part.

Contents

	Page
Technical data	1
Description of exploded view	1
Exploded view	2
Protection circuit	3
Transistor views	3
Block diagram	4
P.C.B. and parts list	5, 6, 7
Schematic diagram	9

Lenco A50

The amplifier A 50 corresponds to the latest technical developments. Special care was taken in its modern design to arrange all operating controls for optimal convenience.

Technical data

Nominal Power, 8 Ω	2 \times 40 W
Distortion at 1 kHz, with 40 W output from both channels	0.2 %
Frequency response at 5 W	10—40,000 Hz
Power Bandwidth	20—40,000 Hz
Sensitivity, Phono	2.5 mV / 50 k Ω
Equalization, Phono	RIAA \pm 1 dB
Sensitivity, Microphone	2.5 mV / 50 k Ω
Sensitivity, AUX, TAPE	160 mV / 50 k Ω
Treble Control	\pm 10 dB at 10 kHz
Bass Control	\pm 10 dB at 100 Hz
Loudness	+ 8 dB at 100 Hz + 4 dB at 10 kHz
High Filter	— 8 dB at 10 kHz
Low Filter	— 8 dB at 100 Hz
Weighted S/N Ratio, to DIN	
— Phono	\geq 56 dB
— AUX, TAPE	\geq 58 dB
Cross Talk	\geq 55 dB at 1 kHz \geq 38 dB at 10 kHz
Power Consumption	250 W max.
Dimensions	430 \times 370 \times 132 mm
Weight	10.5 kg

Descriptions of Exploded View

1. Handle
2. to 7. Knob
8. Bezel (push switch)
9. Acryl lens (meter)
10. Felt (lever switch)
11. LED, LED holder
12. Plate (meter)
13. Bracket for meters
14. VU meter
15. Front frame
16. Mic jack
17. Power switch, power switch
18. Bracket, left side
19. Bracket, lamp holder
20. Lamp, grommet
21. Cover, upper
22. Cover, left side
23. Bracket, lever switch
24. P.C.B. S1014
25. Selector switch
26. P.C.B. S1018
27. Cover, bottom
28. Rubber foot
29. Cover, right side
30. Bracket
31. Bracket, right side
32. Main frame
33. Heat sink
34. Elect. cap. 8200uf/50wv
35. Transformer
36. Power transistor
37. Bracket, heat sink
38. RCA jack 10P
39. RCA jack 4P
40. RCA jack 8P
41. Rear frame
42. Socket protector
43. Din socket 5P
44. Speaker terminal
45. Fuse holder
46. AC cord with plug
47. Voltage selector
48. AC socket

A50 EXPLODED VIEW

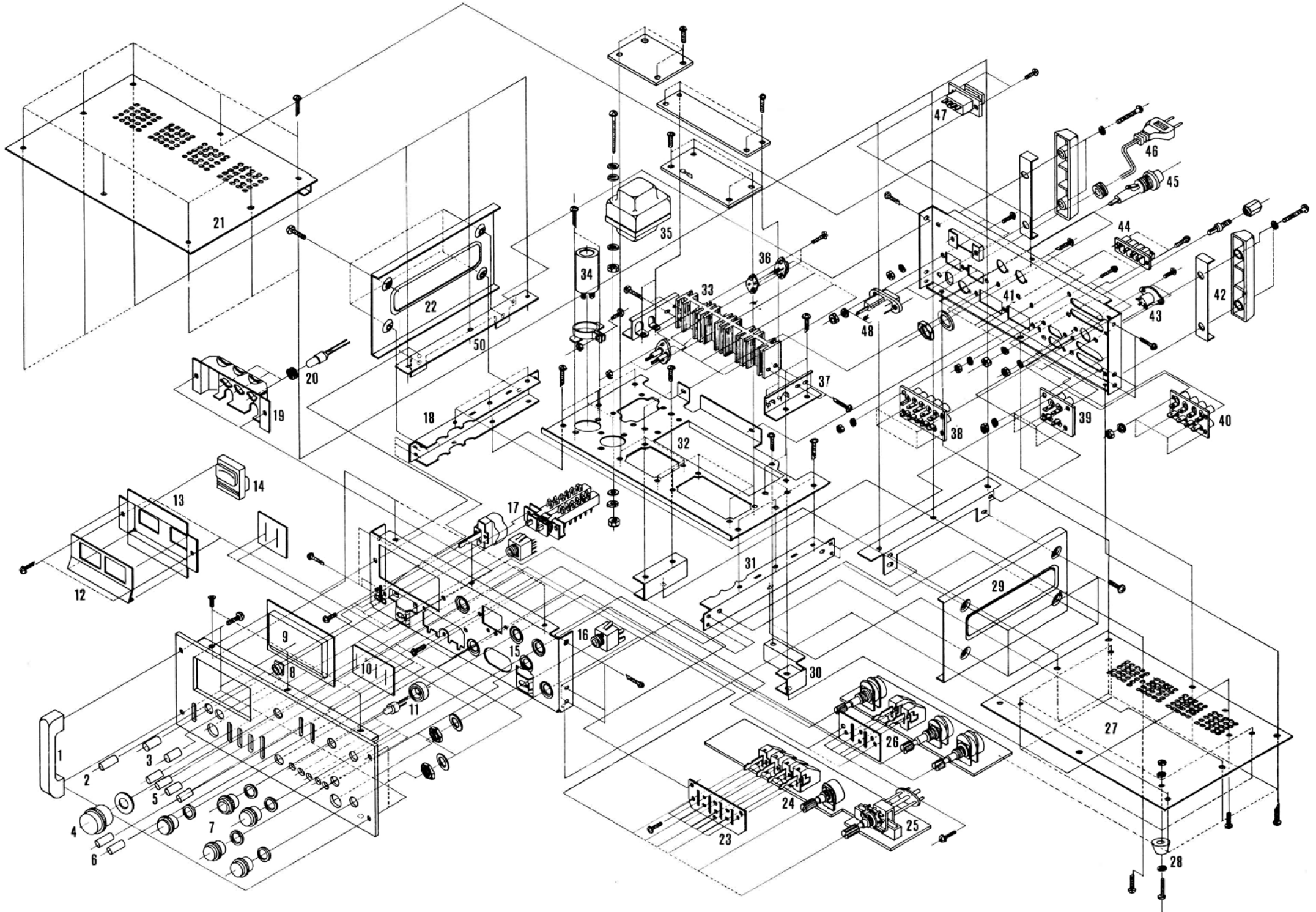

Protection Circuit

1. Transient Muting

A. Biasing circuit

This circuit is designed to protect from the damage which may be caused to speaker and main amplifier by incorrect connection to a high supply voltage and change of supply voltage, etc. This is a bias circuit which delays the operation of main amplifier when power is turned on.

If the rectified voltage is over 40 volts, or C 602 is not charged or if the unit is turned off, Q603 is turned on thus giving a voltage of +26 V and - 26 V on P+ and P—. Under normal conditions, Q601 and Q602 are turned on and P+ and P— are at groundvoltage level.

B. The circuit P is a protection circuit which consists of D501, D502, Q505 and Q 506.

If P+ voltage is more than the turn on voltage of Q505,

Q505 is turned on thus shunting the input current of power transistor Q509.

Likewise, if P— voltage is more than the turn on voltage of Q506, this shunts the input current of Q510. Hence this circuit protects the speaker and power transistor from damage, during switch on, etc.

2. Current Limiter 'L'

This circuit is designed as a protection circuit to protect the speaker and power transistor from damage when the output current increases due to an output short or overload.

If the current through R521 and R522 gives a voltage drop across the resistors which is greater than the turn on voltage of Q507 and Q508, then Q507 and Q 508 are turned on and the input to Q509 and Q510 is shunted. Hence this circuit protects the power transistor and speaker from damage by limiting the current.

Transistor Views

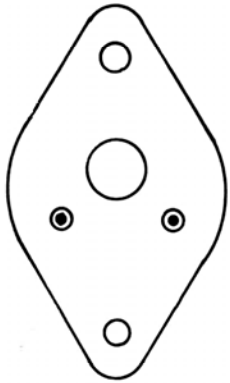

2N 3055

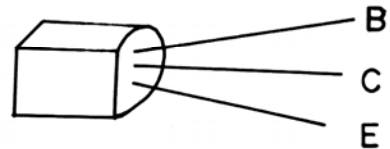
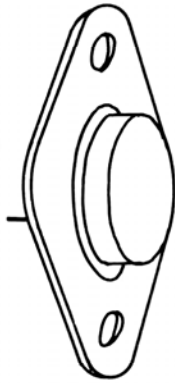

2SA 777
2SC 1849

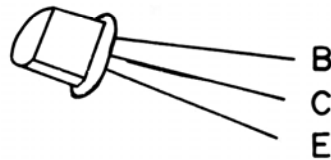

2SA 841 2SC 734
2SA 561 2SC 1681
2SC 732
2SC 733

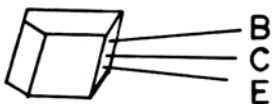

2SC 1166

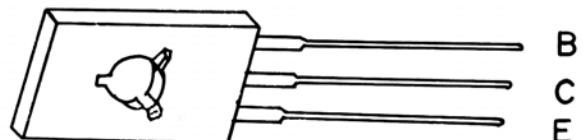

2SA 794
2SC 1567

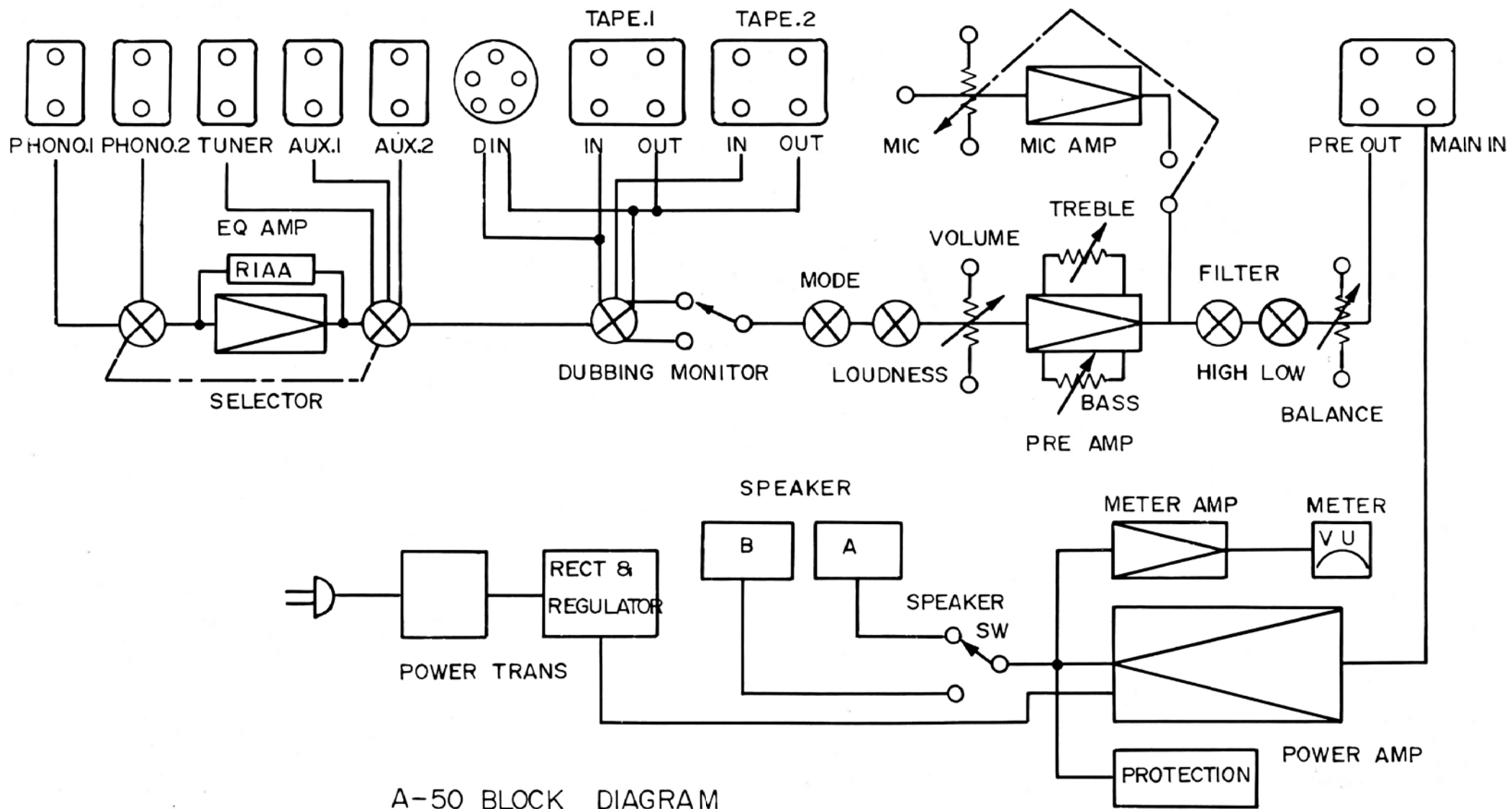

A-50 BLOCK DIAGRAM

P.C.B. and Parts List A50
S1005J Main Amp.

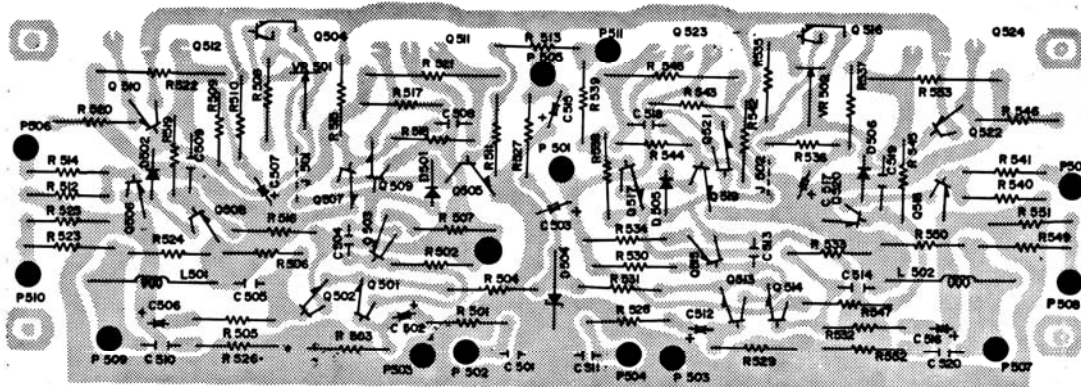

SYMBOL	DESCRIPTION	SYMBOL	DESCRIPTION	SYMBOL	DESCRIPTION	SYMBOL	DESCRIPTION	SYMBOL	DESCRIPTION
R501	1K Ω $\frac{1}{4}$ W $\pm 5\%$	R521	1.33 Ω 2W $\pm 10\%$	R541	10K $\frac{1}{4}$ W $\pm 5\%$	C509	0.01 μ F $\pm 20\%$	Q511	2SD 428
R502	1.5K "	R522	0.33 "	R542	22K "	C510	0.047 $\pm 20\%$	Q512	2SB 559
R503	68K "	R523	330 "	R543	120 "	C511	470P $\pm 10\%$	Q513	2SC 1681
R504	22K "	R524	3.3 "	R544	560 "	C512	0.47 μ F 50WV	Q514	2SC 1681
R505	2.7K "	R525	15 "	R545	560 "	C513	20P $\pm 10\%$	Q515	2SA 777
R506	68K "	R526	10 "	R546	120 "	C515	1 μ F 50WV	Q516	2SC 828
R507	15 Ω "	R527	2.2K "	R547	22K "	C516	10 μ F 10WV	Q517	2SC 734
R508	560 "	R528	1K "	R548	0.33 Ω 2W $\pm 10\%$	C517	47 μ F 35WV	Q518	2SA 561
R509	2.7K "	R529	68K "	R549	330 Ω 1W $\pm 5\%$	C518	0.01 μ F $\pm 20\%$	Q519	2SC 734
R510	2.2K "	R530	1.5K "	R550	3.3 " $\frac{1}{2}$ W "	C519	0.01 μ F $\pm 20\%$	Q520	2SA 561
R511	4.7K "	R531	22K "	R551	15 " $\frac{1}{4}$ W $\pm 5\%$	Q501	2SC 1681	Q521	2SC 1567
R512	4.7K "	R532	2.7K "	R552	10 " 1W $\pm 5\%$	Q502	2SC 1681	Q522	2SA 794
R513	10K "	R533	68K "	R553	0.33 " 2W $\pm 10\%$	Q503	2SA 777	D501	MA 161
R514	10K "	R534	15 "	C501	470P $\pm 10\%$	Q504	2SC 828	D502	MA 161
R515	22K "	R535	550 "	C502	0.47 μ F 50WV	Q505	2SC 734	D504	HZ 14
R516	22K "	R536	2.7K "	C503	1 μ F 50WV	Q506	2SA 561	D505	MA 161
R517	120 "	R537	2.7K "	C504	20P $\pm 10\%$	Q507	2SC 734	D506	MA 161
R518	550 "	R538	4.7K "	C506	10 μ F 10WV	Q508	2SA 561	VR501	500 Ω B
R519	550 "	R539	10K "	C507	47 μ F 35WV	Q509	2SC 1537	VR502	500 Ω B
R520	120 "	R540	4.7K "	C508	0.01 μ F $\pm 20\%$	Q510	2SA 794	L501	2.7MH
	A		B		C		D		

S1020 Sp. Sw. BD

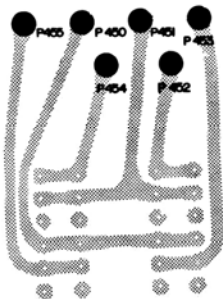

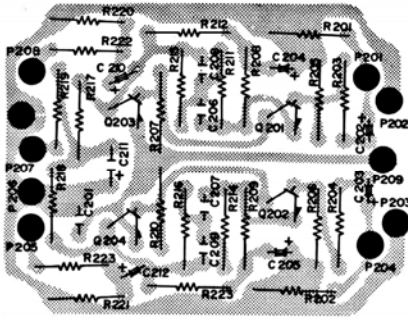

S1014K

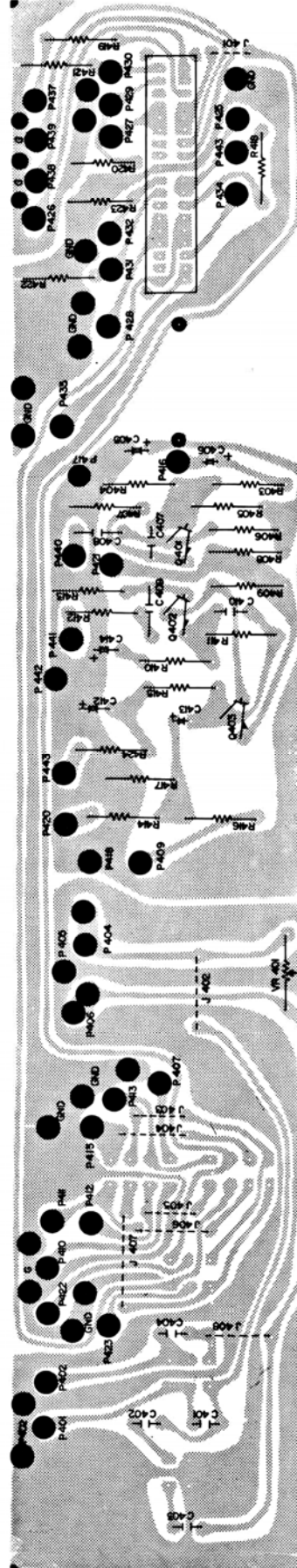

SYMBOL	DESCRIPTION	SYMBOL	DESCRIPTION
R 201	220 K $\frac{1}{4}W \pm 5\%$	R 219	1 K $\frac{1}{4}W \pm 5\%$
R 202	220 K "	R 220	220 K "
R 203	4.7 K "	C 201	4.7UF16V
R 204	4.7 K "	C 202	4.7UF16V (T.T)
R 205	56 K "	C 203	4.7UF16V
R 206	56 K "	C 204	100UF10V
R 207	27 K "	C 205	100UF10V
R 208	560 "	C 206	0.0022 $\mu F \pm 5\%$ (CH)
R 209	560 "	C 207	0.0022 "
R 210	27 K "	C 208	0.0082 "
R 211	33 K "	C 209	0.0082 "
R 212	100 K "	C 210	4.7UF 16V
R 213	100 K "	C 211	220UF 25
R 214	33 K "	C 212	4.7UF 16V
R 215	820 K "	Q 201	2SC1681
R 216	820 K "	Q 202	2SC1681
R 217	15 K "	Q 203	2SA 841
R 218	15 K "	Q 204	2SA 841

SYMBOL	DESCRIPTION	SYMBOL	DESCRIPTION	SYMBOL	DESCRIPTION	SYMBOL	DESCRIPTION	SYMBOL	DESCRIPTION	SYMBOL	DESCRIPTION
R 401	100 K $\frac{1}{4}W \pm 5\%$	R 421	1.5 M $\frac{1}{4}W \pm 5\%$	C 401	0.02 $\mu F \pm 5\%$ (CH)	C 411	220 μF 25WV				
R 402	2.2 K "	R 422	1.5 "	C 402	0.0068 "	C 412	4.7 μF 16WV				
R 403	2.2 K $\frac{1}{4}W \pm 5\%$	R 423	1.5 "	C 403	0.0068 "	C 413	4.7 μF 16WV				
R 404	12 K "	R 424	5.6 K "	C 404	0.02 "	C 414	100 μF 10WV				
R 405	180 K "			C 405	100 μF 16WV						
R 406	27 K "			C 406	1 μF 50WV						
R 407	1 K "			C 407	100P $\pm 10\%$						
R 408	10 K "			C 408	0.047 $\mu F \pm 20\%$						
R 409	18 K "			C 409	0.047 "						
R 410	330 "			C 410	68P $\pm 10\%$						

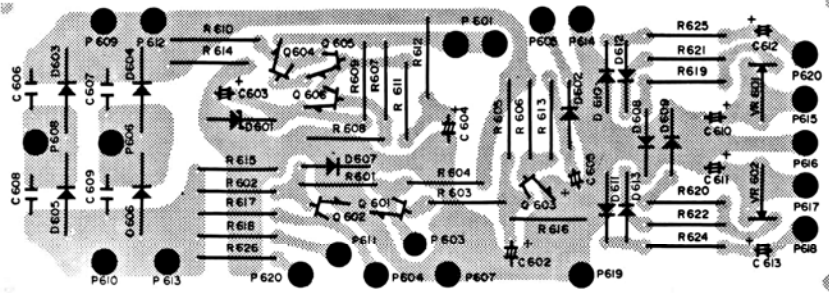

SYMBOL	DESCRIPTION	SYMBOL	DESCRIPTION	SYMBOL	DESCRIPTION	SYMBOL	DESCRIPTION	SYMBOL	DESCRIPTION
R601	5.6K 1/4W ±5%	R616	22K 1/4W ±5%	C607	0.01µF ±8%	D601	HZ 7B	VR601	1K B
R602	56K "	R617	4.7K "	C608	0.01µF ±8%	D602	MA 161	VR602	1K B
R603	10K "	R618	3.9K "	C609	0.01µF ±8%	D603	30D1		
R604	4.7K "	R619	560 "	C610	47µF 6.3V	D604	"		
R605	150K "	R620	560 "	C611	47µF 6.3V	D605	"		
R606	33K "	R621	47K "	C612	1µF 50 WV	D606	"		
R607	1K "	R622	47K "	C613	1µF 50 WV	D607	MA 161		
R608	1.2K "	R624	8.2K "	C614	10µF 25 WV	D608	1N60		
R609	4.7K "	R625	8.2K "	Q601	2SC 734	D609	1N60		
R610	330 1W ±5%	R626	2.2K "	Q602	2SA 561	D610	1N60		
R611	10 K 1/4W ±5%	C602	220µF 10 WV	Q603	2SC 733	D611	1N60		
R612	10K "	C603	10µF 10 WV	Q604	2SC 1166	D612	1N34		
R613	4.7K "	C604	100µF 25 WV	Q605	2SC 733	D613	1N34		
R614	4.7K "	C605	33µF 10 WV	Q606	2SC 733				
R615	4.7K "	C606	0.01µF ±8%						

S1018J Pre Amp.

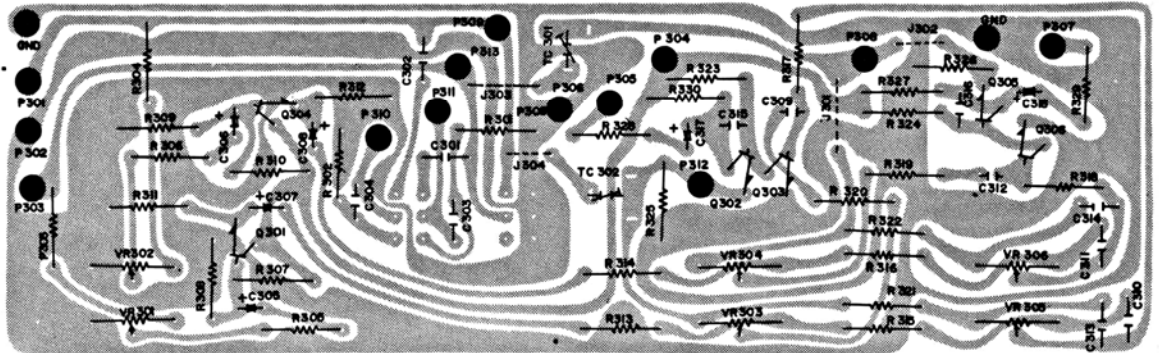

SYMBOL	DESCRIPTION	SYMBOL	DESCRIPTION	SYMBOL	DESCRIPTION	SYMBOL	DESCRIPTION
R 301	8.2 K ± 5% 1/4W	R 316	10 K ± 5% 1/4W	C 301	220 P ± 10 %	C 317	2.2/16 (T.T)
R 302	8.2 K "	R 317	22 K "	C 302	220 P "	C 318	2.2/16 (T.T)
R 303	10 K "	R 318	22 K "	C 303	0.047 (M) ± 5 %	TC 301	30 P ± 10 %
R 304	10 K "	R 319	4.7K "	C 304	0.047 (M) "	TC 302	30 P "
R 305	3.9 K "	R 320	4.7K "	Q 305	2.2/16 (T.T)	Q 301	C 1681
R 306	3.9 K "	R 321	10 K "	C 306	2.2/16 (T.T)	Q 302	C 732
R 307	220K "	R 322	10 K "	C 307	4.7/16 "	Q 303	C 732
R 308	220K "	R 323	150K "	C 308	4.7/16 "	Q 304	C 1681
R 309	220K "	R 324	150K "	C 309	0.001 (M) ± 5%	Q 305	C 732
R 310	220K "	R 325	680 "	C 310	0.047 (M) "	Q 306	C 732
R 311	27 K "	R 326	680 "	C 311	0.047 (M) "	VR 301	100 K (A)
R 312	27 K "	R 327	4.7 K "	C 312	0.001 (M) "	VR 302	100 K (A)
R 313	470 "	R 328	1 K "	C 313	0.047 (M) "	VR 303	100 K (B)
R 314	470 "	R 329	1 K "	C 314	0.047 (M) "	VR 304	100 K (B)
R 315	10 K "	R 330	4.7 K "	C 315	30 P ± 10 %	VR 305	100 K (B)
				C 316	30 P "	VR 306	100 K (B)

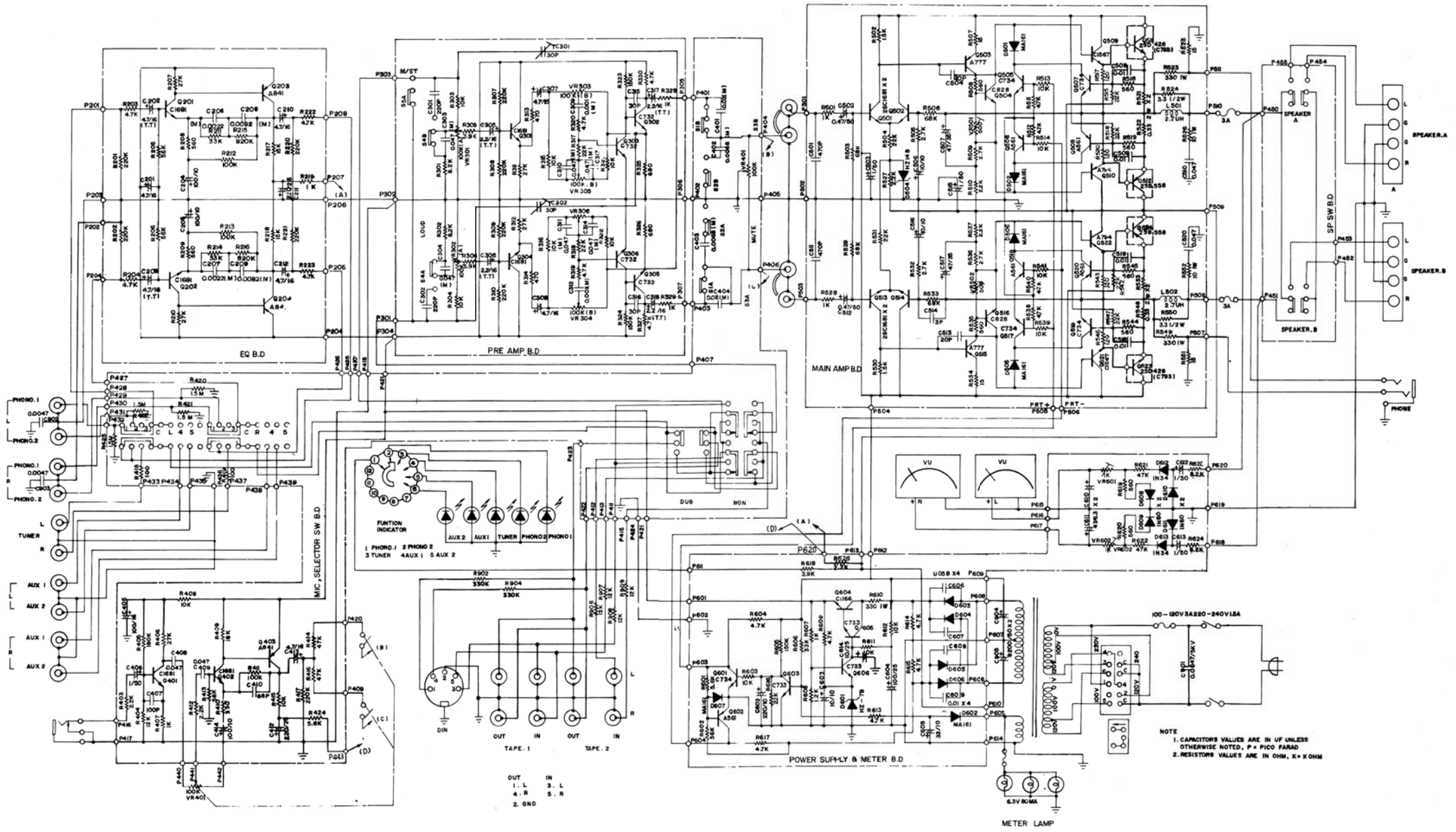

Lenco Ltd.
A50